



Vixen Co., Ltd. 5-17-3 Higashitokorozawa, Tokorozawa, Saitama 359-0021, Japan
Phone +81-4-2944-4141(International)
<https://www.vixen.co.jp> Fax +81-4-2944-9722(International)

67 号 - 10 - (80000206) - 1S-12.6 - (g) (水)

INSTRUCTION MANUAL

This instruction manual is in common between ATERA H12x30 and ATERA H10x21 Binoculars with Vibration-Canceller. It describes the ATERA H12x30 mainly, but the same usage is applied for the ATERA H10x21.

PART NAME / CONTENTS

The picture is H12x30 model.

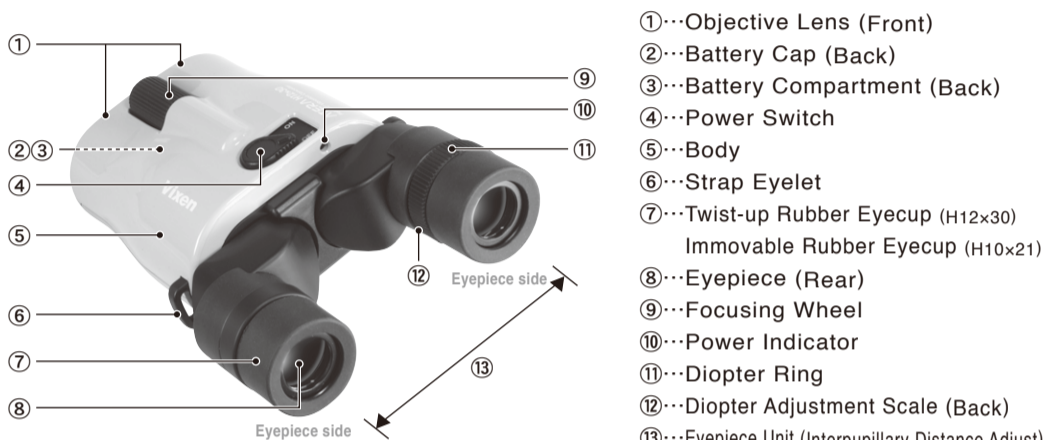

- ①...Objective Lens (Front)
 - ②...Battery Cap (Back)
 - ③...Battery Compartment (Back)
 - ④...Power Switch
 - ⑤...Body
 - ⑥...Strap Eyelet
 - ⑦...Twist-up Rubber Eyecup (H12x30)
Immovable Rubber Eyecup (H10x21)
 - ⑧...Eyepiece (Rear)
 - ⑨...Focusing Wheel
 - ⑩...Power Indicator
 - ⑪...Diopter Ring
 - ⑫...Diopter Adjustment Scale (Back)
 - ⑬...Eyepiece Unit (Interpupillary Distance Adjust)
-
- ①...ATERA Binoculars
 - ②...Soft Case
 - ③...Neck Strap
 - ④...Two AAA Batteries (Checking purpose only)
 - ⑤...Instruction Manual (Combined with Warranty)



Figure 7

HOW TO USE③

- Remove the eyepiece caps from the unit. When using the unit with your eyeglasses worn, follow the instructions below. The fully field of view will be obtained even if you use eyeglasses to look through.
Twist-up Rubber Eyecup (Available for H12x30 only.)
When look through the unit with eyeglasses worn, leave the eyecup at the lowest position. When using the unit with the naked eye or wearing contact lens, pull up the eyecup to secure the field of view. (Ref. Figure 7)
When storing the unit in the carry case, put back the eyecups to the lowest position.

Turn on the power switch. The vibration canceller starts activating and the green power indicator will light.

Note:

The unit may buzz and can slightly vibrate as you turn on the power, but it is not a vibration canceller malfunction. The vibration ceases when the power switch is securely set in place.

Auto Power off

The vibration cancellation function stops automatically (and the power indicator goes off) in 5 minutes after turning on the unit. If you restart the vibration canceller, turn off the unit and then turn on again.

- While looking through the binocular with both eyes, adjust the interpupillary distance between the space of the eyepieces so that the field of view can be seen as one circle. Be sure to make the adjustments with a distant object.

Hold the part of the eyepieces with both hands when you adjust the interpupillary distance. It allows you to make the adjustments smooth. (Ref. Figure 8)

Interpupillary Distance Adjustments

This is to adjust the distance between the two eyepieces to fit your eyes. Inadequate interpupillary distance may result in eyestrain.

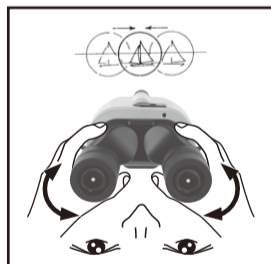

Figure 8

HOW TO USE⑤

Attaching the straps

Attach the supplied strap to the strap eyelet as illustrated. (Ref. Figure 12)

How to put the strap through the strap ring:

As shown in the diagram, straighten and press down the tip of the strap with fingers. (Ref. Figure 13)
Next, move the strap ring so that the tip of the strap goes through the strap ring.

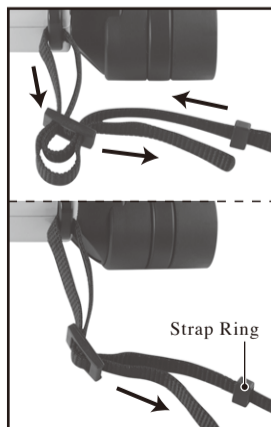

Figure 12

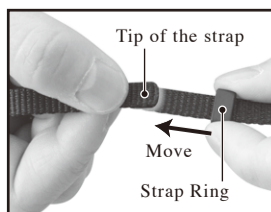

Figure 13

ABOUT THE VIBRATION CANCELLATION FUNCTION

This binocular employs the vibration cancellation function that is called gimbal control system. If sudden movement (such as moving downward the binocular suddenly from its lateral position) happens during the vibration canceller is in operation, it may spoil functioning correctly the vibration canceller. If this is the case, turn off the power and then turn on again.

HOW TO USE①

Insert the Batteries

Use the supplied two AAA batteries. (Provides for checking purpose only)

- Confirm the power switch is turned to the OFF position. Pick up the both sides of the battery cap by fingers to open as shown in the photo. (Ref. Figure 1)
- With checking the polarity of the batteries, insert the batteries into the battery compartment. (Ref. Figure 2)
- Replace the battery cap as it was placed. (Ref. Figure 3)



Figure 1

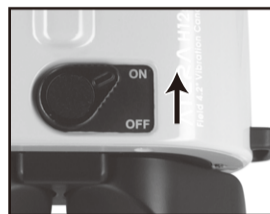

Figure 4



Figure 2

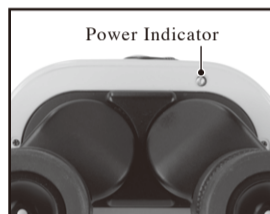

Figure 5

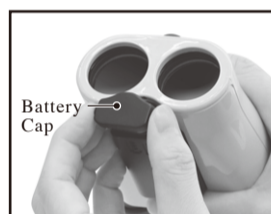

Figure 3

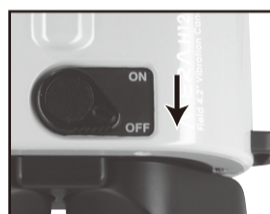

Figure 6

HOW TO USE②

- Make sure that the power switch is turned to the ON position if you turn on the power. (Ref. Figure 4)
The power indicator will light in green. (Ref. Figure 5)
- Turn the power switch to the OFF position if you don't use the unit. (Ref. Figure 6)

Note:

If the power indicator (green light) blinks, the batteries are being exhausted. If this is the case, the vibration canceller may not work properly. Replace the batteries with fresh ones.

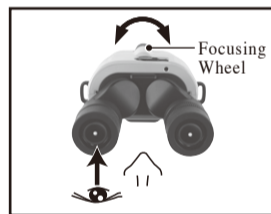

Figure 9

HOW TO USE④

- For diopter adjustments, find a distant object to look through. While looking through the left eyepiece with the left eye, focus on the object by turning the focusing wheel. (Ref. Figure 9)

- Then, while looking through the right eyepiece with the right eye, focus on the same object by turning the diopter ring.

It is convenient for you to remember the position of the diopter ring scale so that you can set the diopter ring swiftly without repeating the above procedure every time you use the binocular. (Ref. Figure 10)

- Once you have brought the unit into focus with both eyes, you use the focusing wheel only to focus on different objects. (Ref. Figure 11)

Diopter Adjustment

This is for those who have different eyesight in right and left eyes. The diopter ring can compensate for the difference in the right and left eyesight.

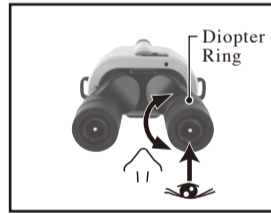

Figure 10

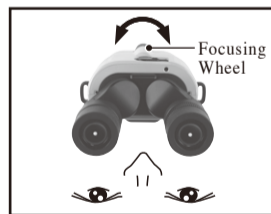

Figure 11

SPECIFICATIONS

Model	H12x30	H10x21	Model	H12x30	H10x21
Magnification	12x	10x	Eye Relief	17.5mm	16mm
Objective Aperture	30mm	21mm	Near Focus	About 2.5m	About 3m
Prism	BK7 (Roof prism)		Inter Pupillary Distance	55 - 75mm	
	BaK4 (subsidiary prism)		Anti-Vibration	2 axis gimbal control vibration canceller with automatic power off (after 5 minutes of no motion)	
Coatings	Fully multicoated optics		Vibration Correction Angle	About +/-3degrees	
	Phase coatings		Battery Duration	About 12hours (at temperature of 20degree-C with use of two fresh AAA batteries)	
Real Field of View	4.2°degrees	4.8°degrees	Waterproofness	No	
Apparent Field *2	47.5°degrees	45.5°degrees	Dimensions	14.9x10.8x6.2cm	13.0x10.7x6.3cm
Field at 1000m	73m	84m	Weight	422g (without battery)	358g (without battery)
Exit Pupil	2.5mm	2.1mm	Tripod Adapter Socket	No available	
Brightness	6.3	4.4			

*1 High Reflectivity Coating : Dielectric coatings are applied to maximize the reflection of roof prisms to produce clearer and brighter views. Specifications are subject to change without prior notice.

*2 Calculated according to the standard JIS B7157 : 2003

PREFACE

Thank you for your purchase of the Vixen products.
For safety use, observe the following precautions.

1. Before using the product for the first time, read "HOW TO USE" and "OPERATION PRECAUTIONS".
2. Keep this instruction manual at hand every time you use it for reference.
3. Some descriptions in "SAFETY PRECAUTIONS" and "OPERATION PRECAUTION" may not be applied for all models.

This instruction manual describes information on matters for safety operation of the product to prevent user or others from injury or property damage. Before use, comprehend the operation of the product.

(The specifications and appearance are subject to change without notice.)

SAFETY PRECAUTIONS

WARNING

Denotes that, if ignored or applied incorrectly, creates the possibility of death or serious personal injury.

CAUTION

Denotes that, if ignored or applied incorrectly, creates the possibility of personal injury or property damage.

OPERATION PRECAUTION

Denotes that, if ignored or applied incorrectly, may adversely affect the product performance or reliability.

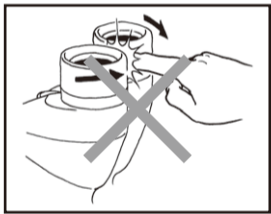

Figure 4

SAFETY PRECAUTIONS②

CAUTION

- Be careful not to pinch your fingers when adjusting the interpupillary distance. (Ref. Figure 4)



Figure 5

- Keep away caps desiccant agent or plastic bags from children to avoid swallowing. (Ref. Figure 5)

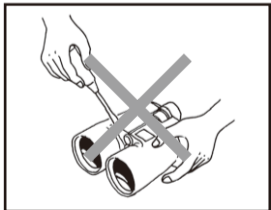

Figure 6

- Do not take the product apart. (Ref. Figure 6)
- When product are used continuously over a sustained period, you may get inflammation of skin around your eyes coming in contact with rubber eyepieces. If you experience this symptom, please stop using it and consult with a doctor immediately.

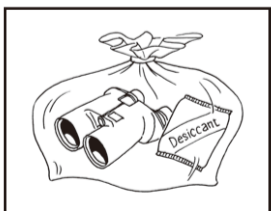

Figure 9

OPERATION PRECAUTIONS②

- STORAGE -

5. Store the product in a dry, well ventilated place. Storage and use of the product in humid environment may cause the lens to fog up or fungus to form. Let the product dry indoors before storing it, especially after using it at night or on a rainy day.

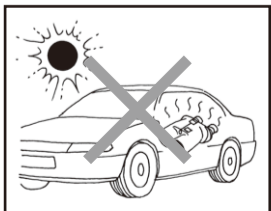

Figure 10

6. For a long-term storage, place the product in a plastic bag or an airtight container with a desiccant agent. Take the product out from the case occasionally for ventilation, if it is not used for a long time. Replace the desiccant with a new one at the time. (Ref. Figure 9)
7. Do not leave the product in a car on a hot day or near a heater. The heat may deform or damage the product. (Ref. Figure 10)
8. Retract the sliding type eyecups back into place before storing the product in a case. The eyepieces on the IF (individual focus) binoculars should also be retracted for storage.

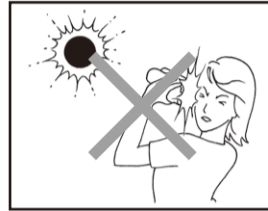

Figure 1

SAFETY PRECAUTIONS①

WARNING

- Never look at sun through the product. Instantaneous and irreversible damage to your eyes will occur and may result in total loss of eyesight. (Ref. Figure 1)



Figure 2

CAUTION

- Do not use the product while walking. It may result in a collision or a fall, and could cause injury. (Ref. Figure 2)
- Do not leave the product in an unstable place. It may tip over or drop, resulting in injury or damage.
- Do not swing the product by the strap. It may hit someone and cause injury. (Ref. Figure 3)
- The case, straps, and the rubber material on the body may deteriorate over a long period and may cause stain on the clothing. Please check the condition before use.

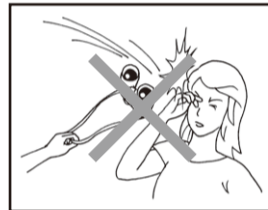

Figure 3

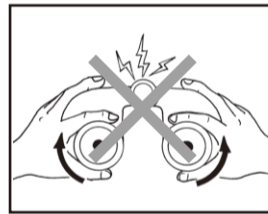

Figure 7

OPERATION PRECAUTIONS①

- HANDING AND USAGE -

1. Do not try to open or close the body angle beyond its limit. Also, do not try to turn the diopter ring, the center focus ring, or the zoom ring beyond their limits. (Ref. Figure 7)
2. Do not subject the product to shocks. If you accidentally hit or drop the product and the image appears abnormal, please consult Vixen customer service. (Ref. Figure 8)
3. The lens may fog up due to sudden temperature change such as when bringing the product into a warm room from cold outdoors. Should this occur, let the product dry naturally at normal temperature.
4. Keep the product away from rain, water splash, salt water, sand, and mud. Waterproof product may be used in rain or in wet environments, but wipe them dry after use.



Figure 8

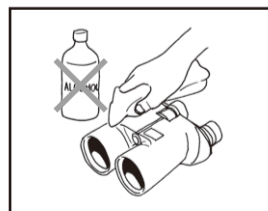

Figure 11

OPERATION PRECAUTIONS③

- CARE AND MAINTENANCE -

9. To clean the body surface, dust it off lightly and wipe it using a clean cloth. After usage by seaside, wipe it with a clean moist cloth to remove the salt and then wipe it dry with a dry cloth. Do not use benzene, paint thinner, or a cleaner containing alcohol. (Ref. Figure 11)

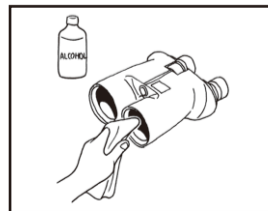

Figure 12

10. Blow off all abrasive dirt and dust on the lens surface with a camera cleaning blower or a soft oil-free brush. With the dust removed, use a lens cleaning tissue moistened with a few drops of a lens cleaning solution for fingerprints. Wipe it out gently. (Ref. Figure 12)
The lens surface is very susceptible to scratches. In cleaning much care must be taken to avoid damaging the lens surface. Read instructions for a lens cleaning solution thoroughly if it is used.

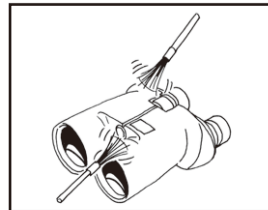

Figure 13

11. Use a brush to remove sands and dirt from the rotating parts on the focusing wheel and the diopter ring. (Ref. Figure 13)